





Инструкция по установке

TOYOTA COROLLA

(2007-2019)



Арт.: F.5712.001

 <p>1300 kg</p>	 <p>75 kg</p>	 $D \text{ (kN)} = \frac{\text{MAX kg} \times \text{MAX kg}}{\text{MAX kg} + \text{MAX kg}} \times 0,00981$ 
<p>D = 7.3 kN</p>		

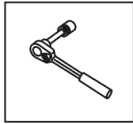

Вкрутить/выкрутить используя инструмент

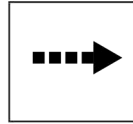

Движение

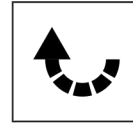

Поворот



Вкрутить/выкрутить не затягивая

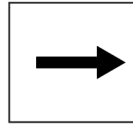

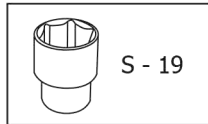
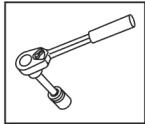

Расположение

Используемый инструмент:

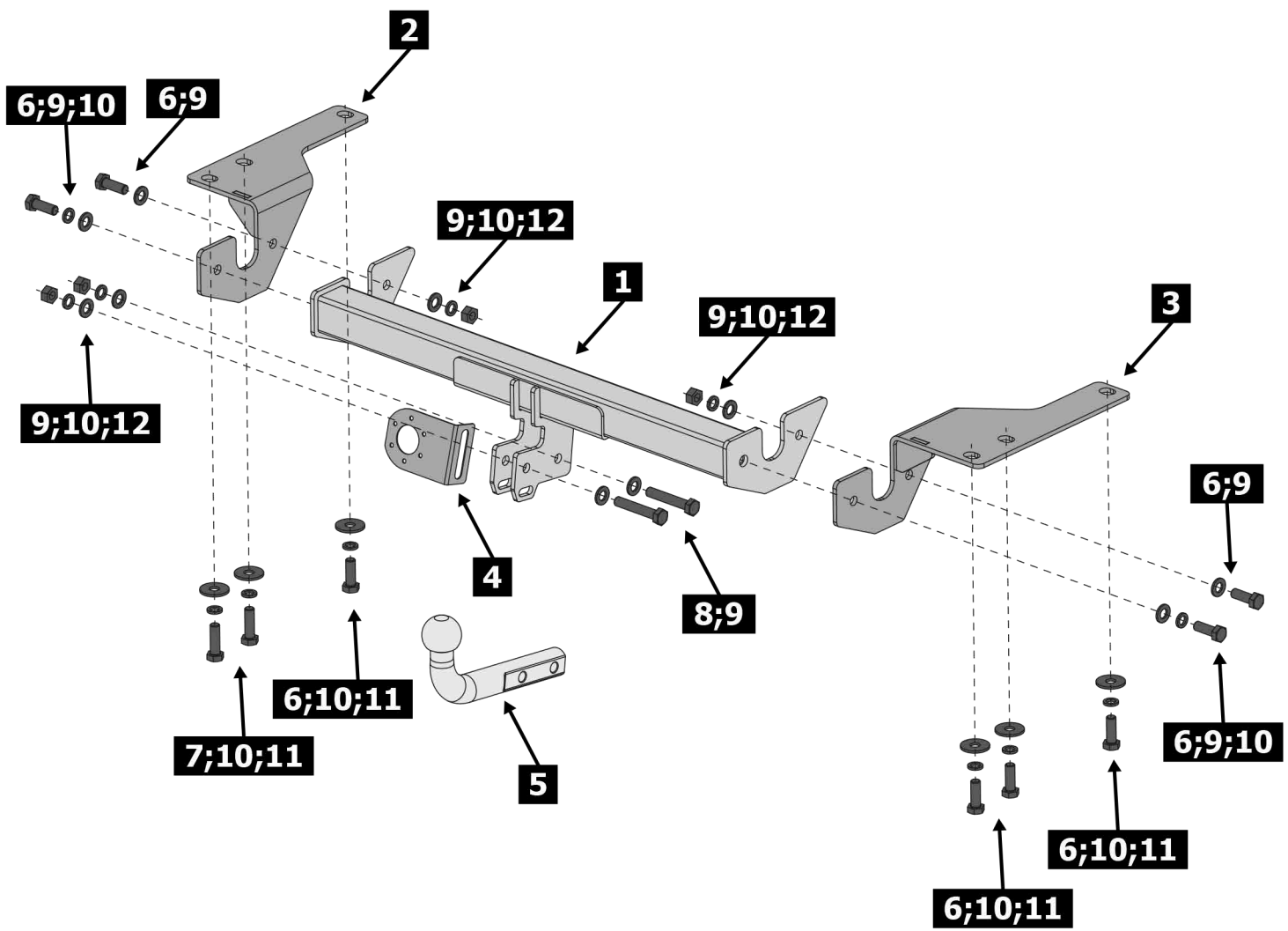

S - 19

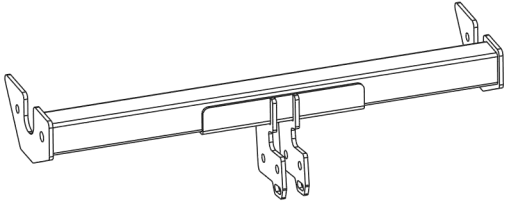
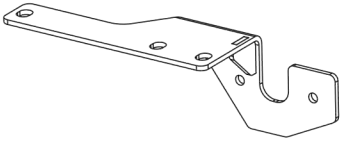
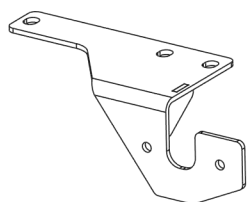
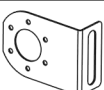
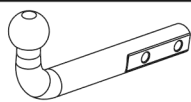
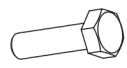
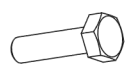
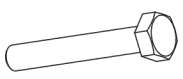

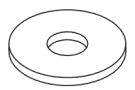
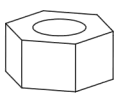
1	x1	Балка	
2	x1	Кронштейн балки левый	
3	x1	Кронштейн балки правый	
4	x1	Подрозетник	
5	x1	Крюк	
6	x8	M12x1.25x35	
7	x2	M12x1.25x40	
8	x2	M12x1.25x70	
9	x10	∅ 12	
10	x12	∅ 12	
11	x6	∅ 12	
12	x4	M12x1.25	

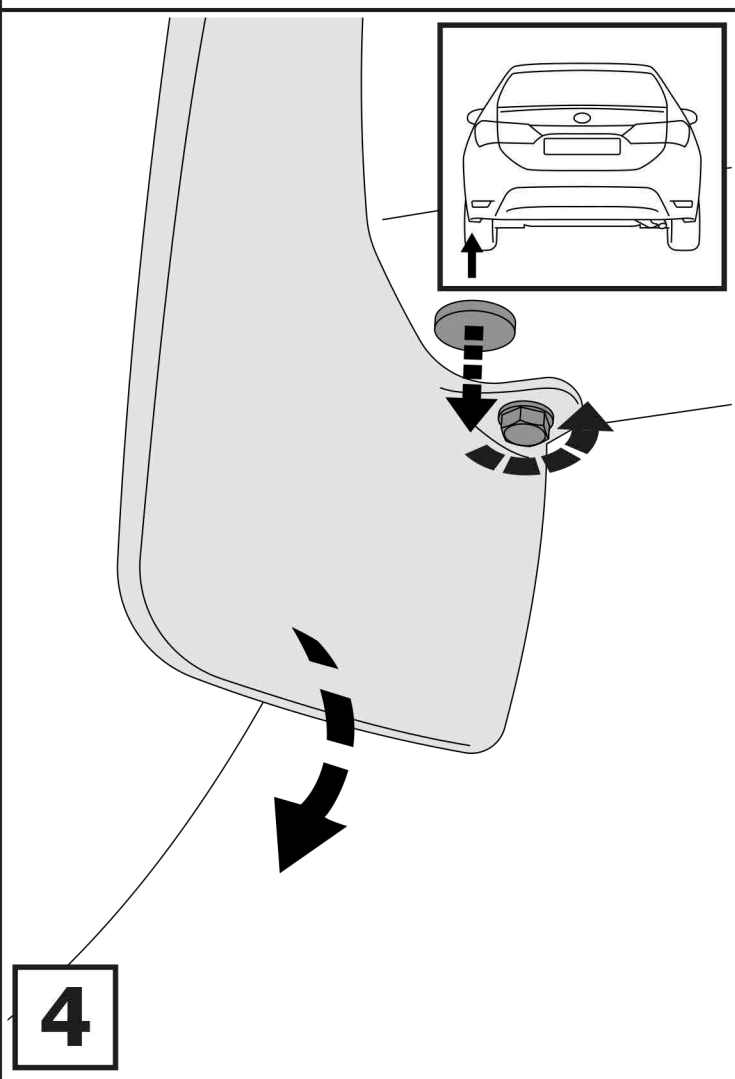
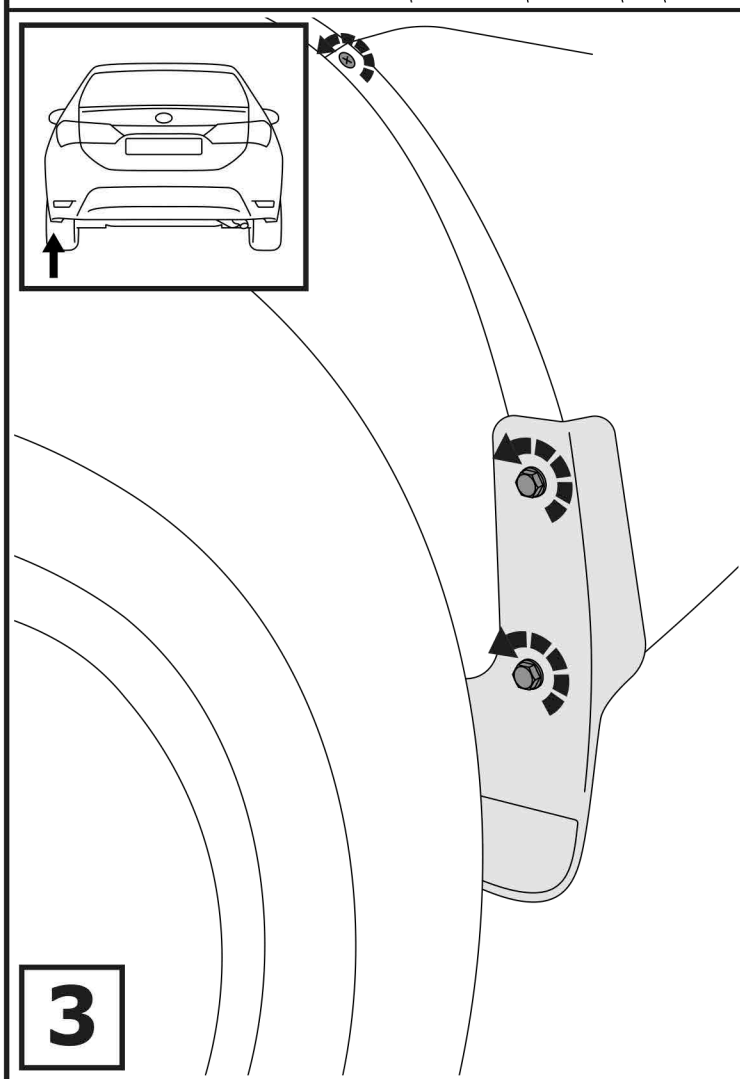
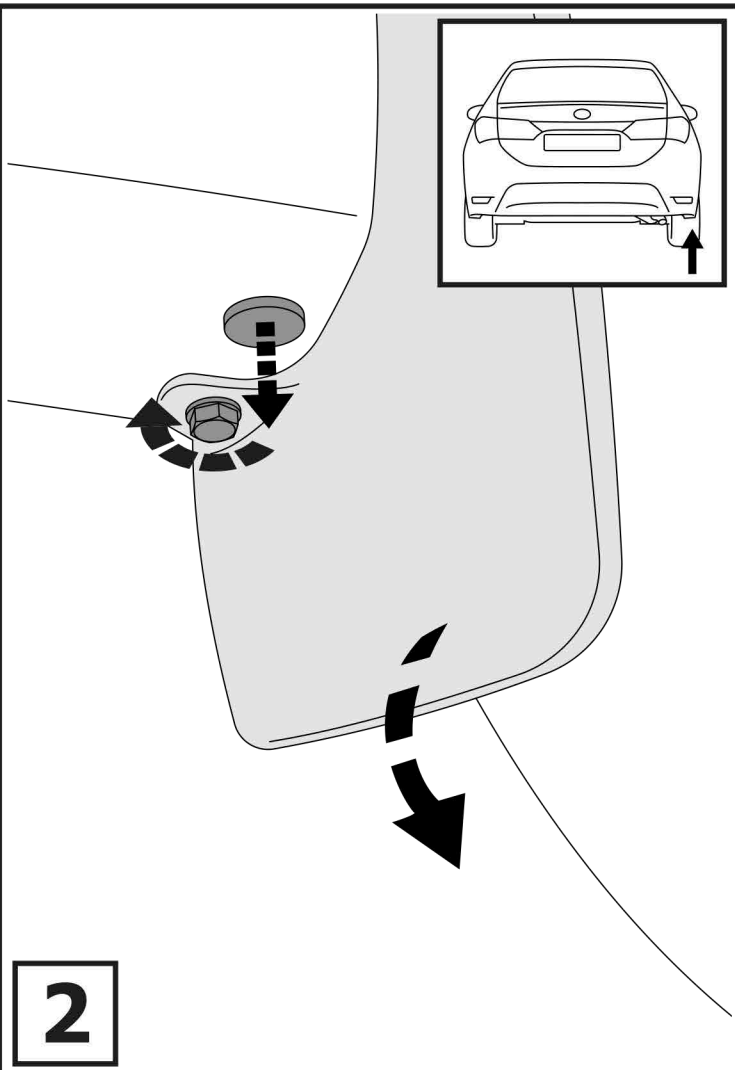
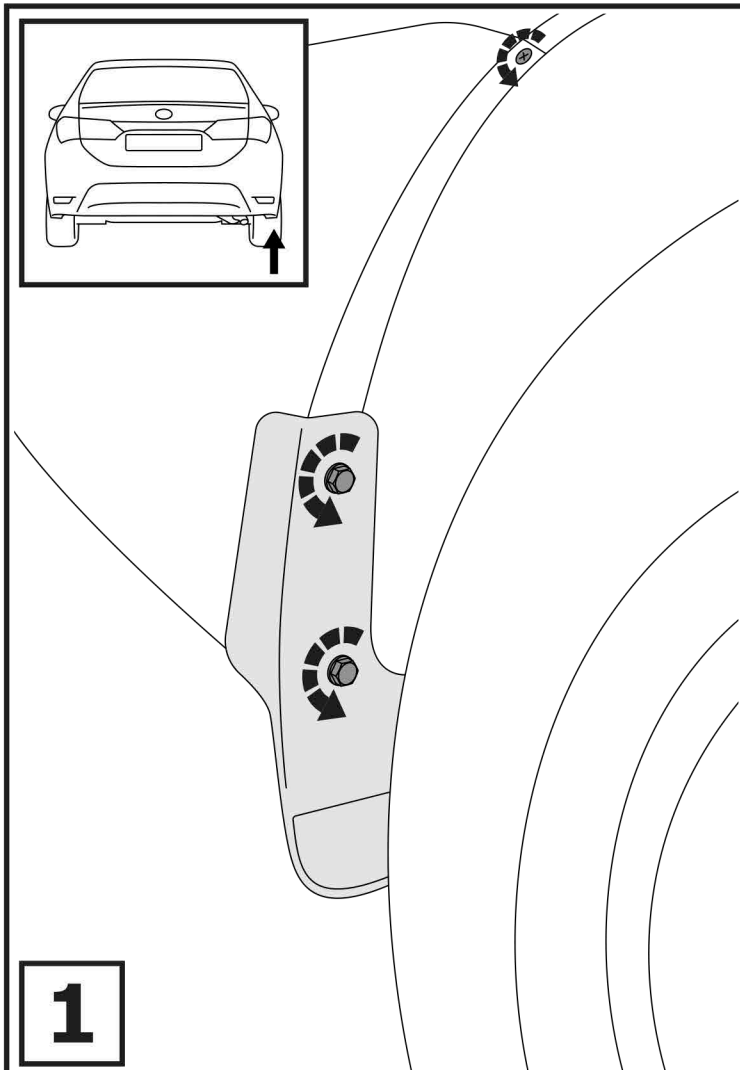

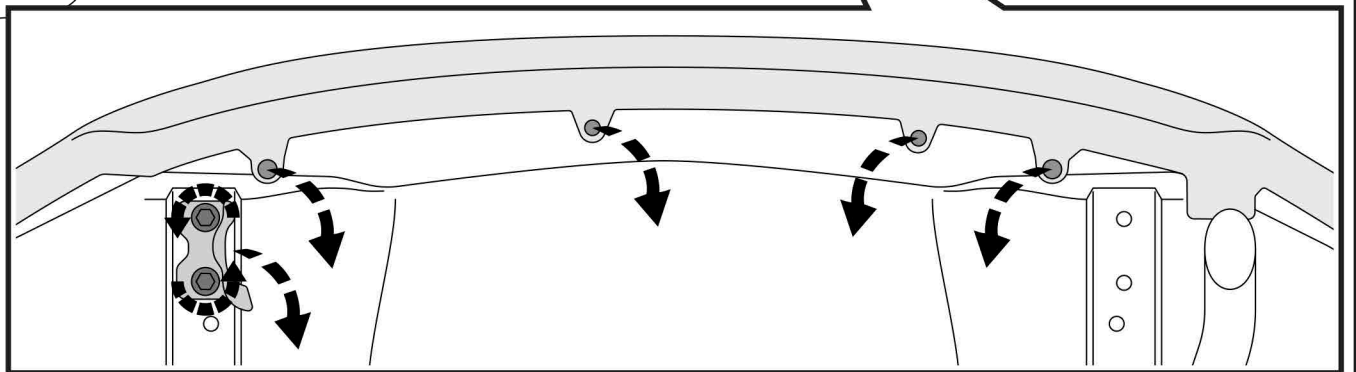
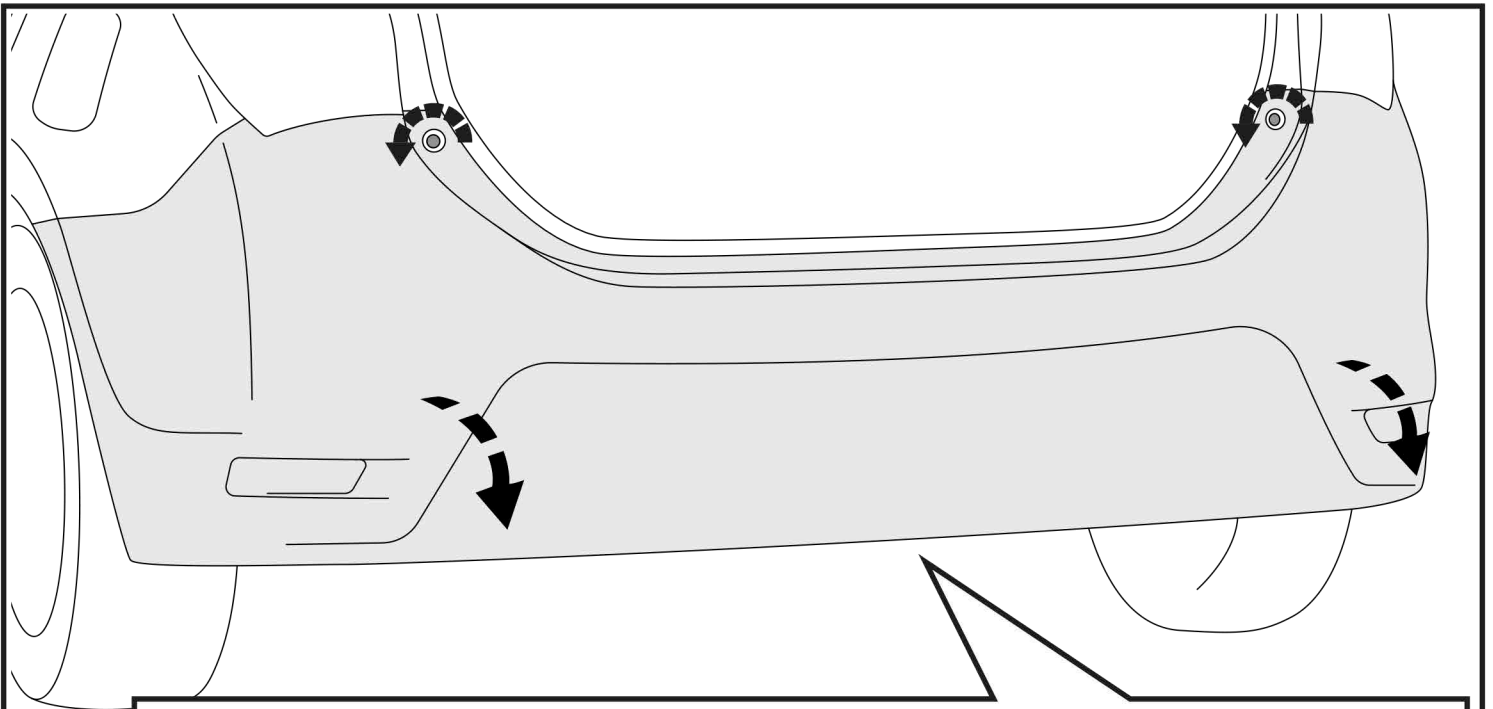

5

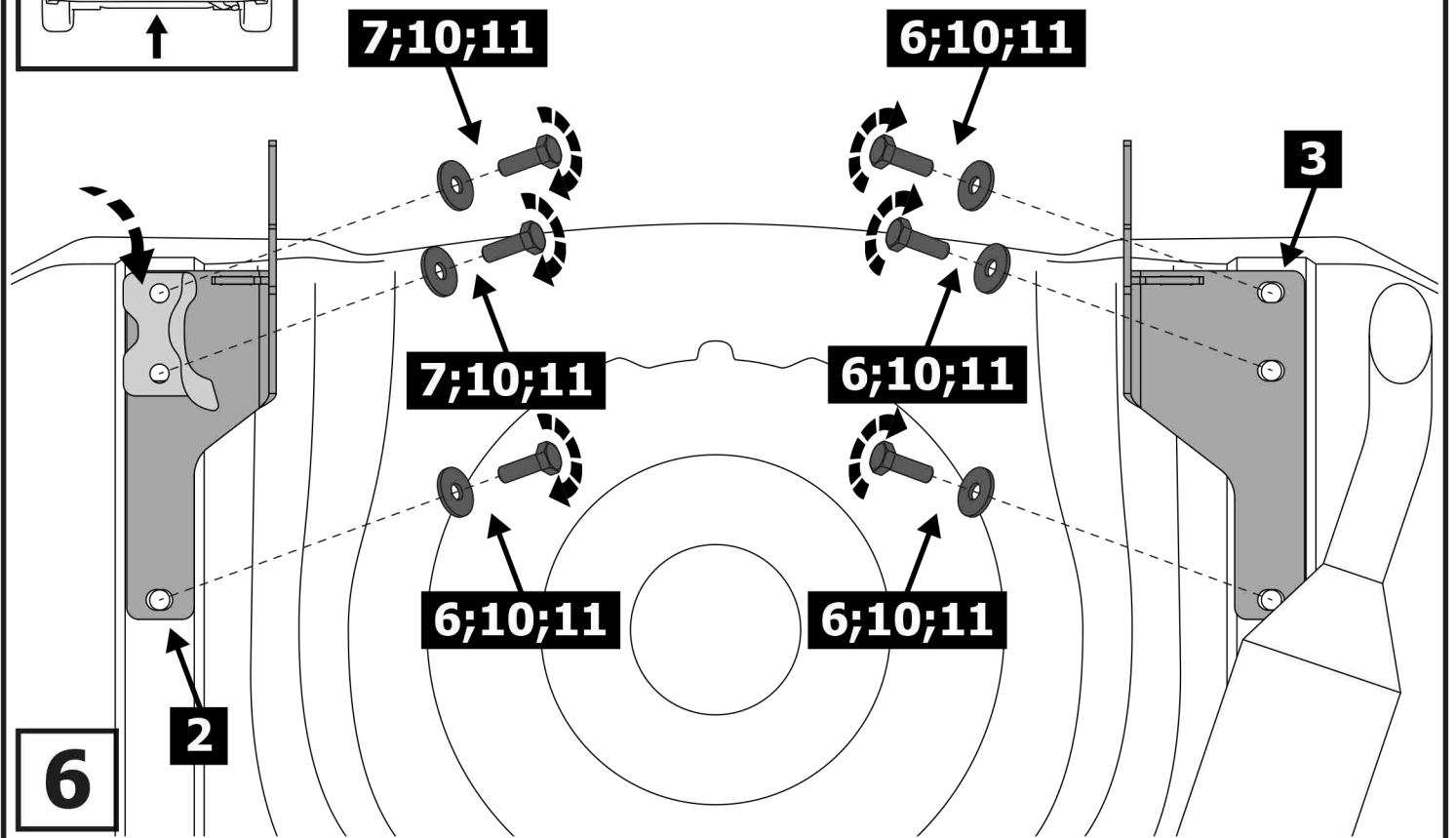
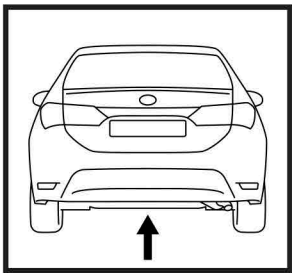

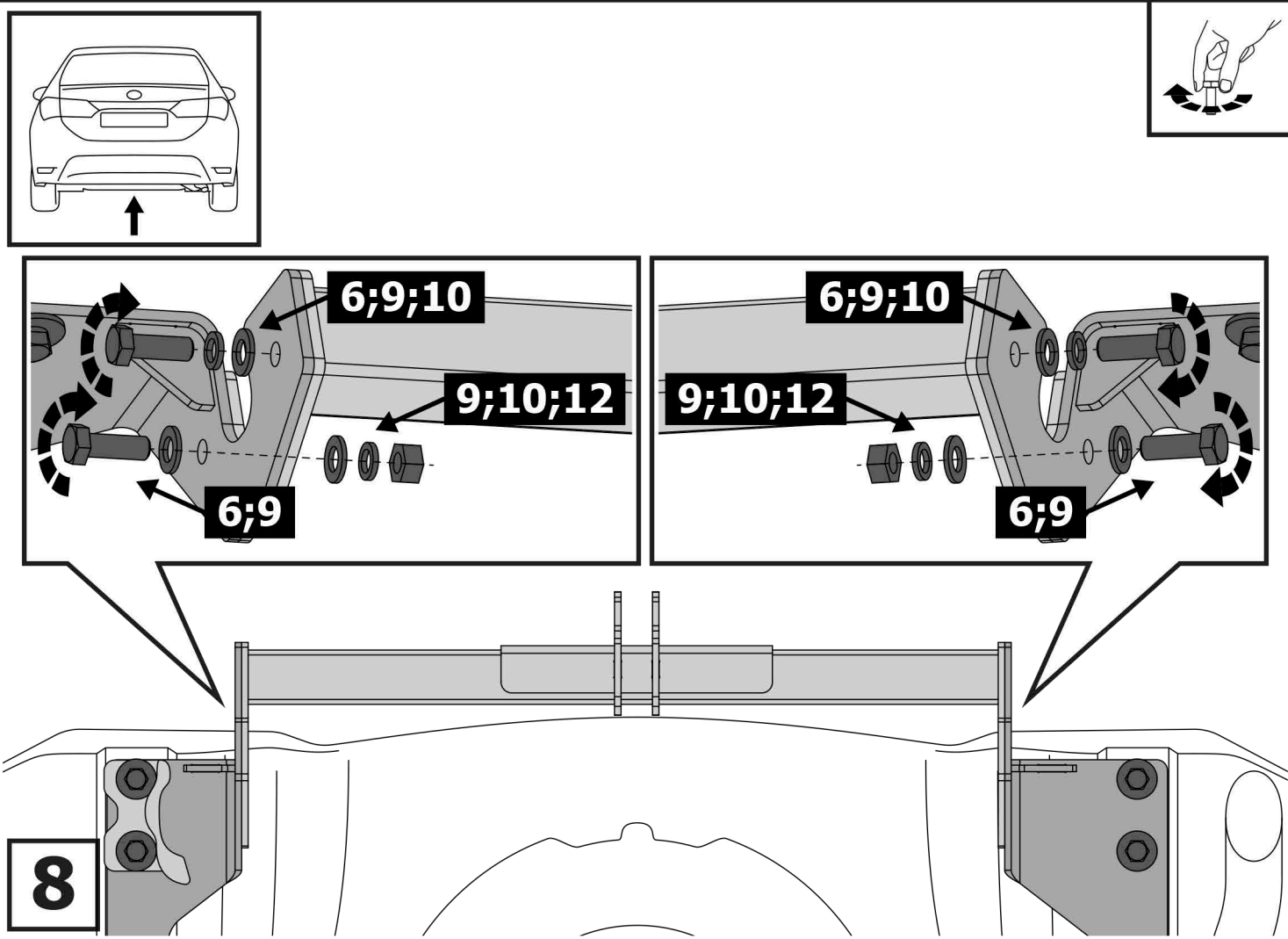
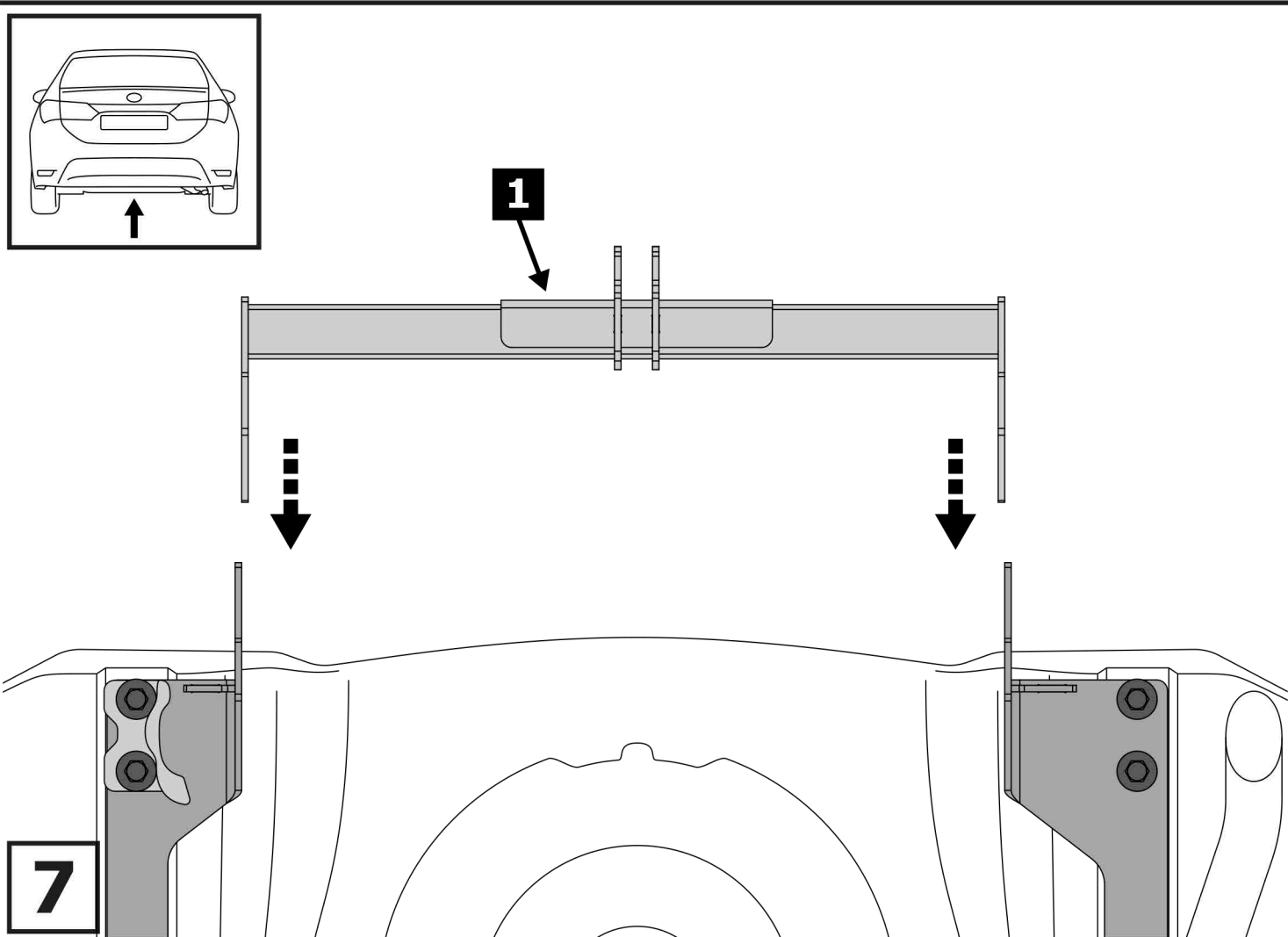

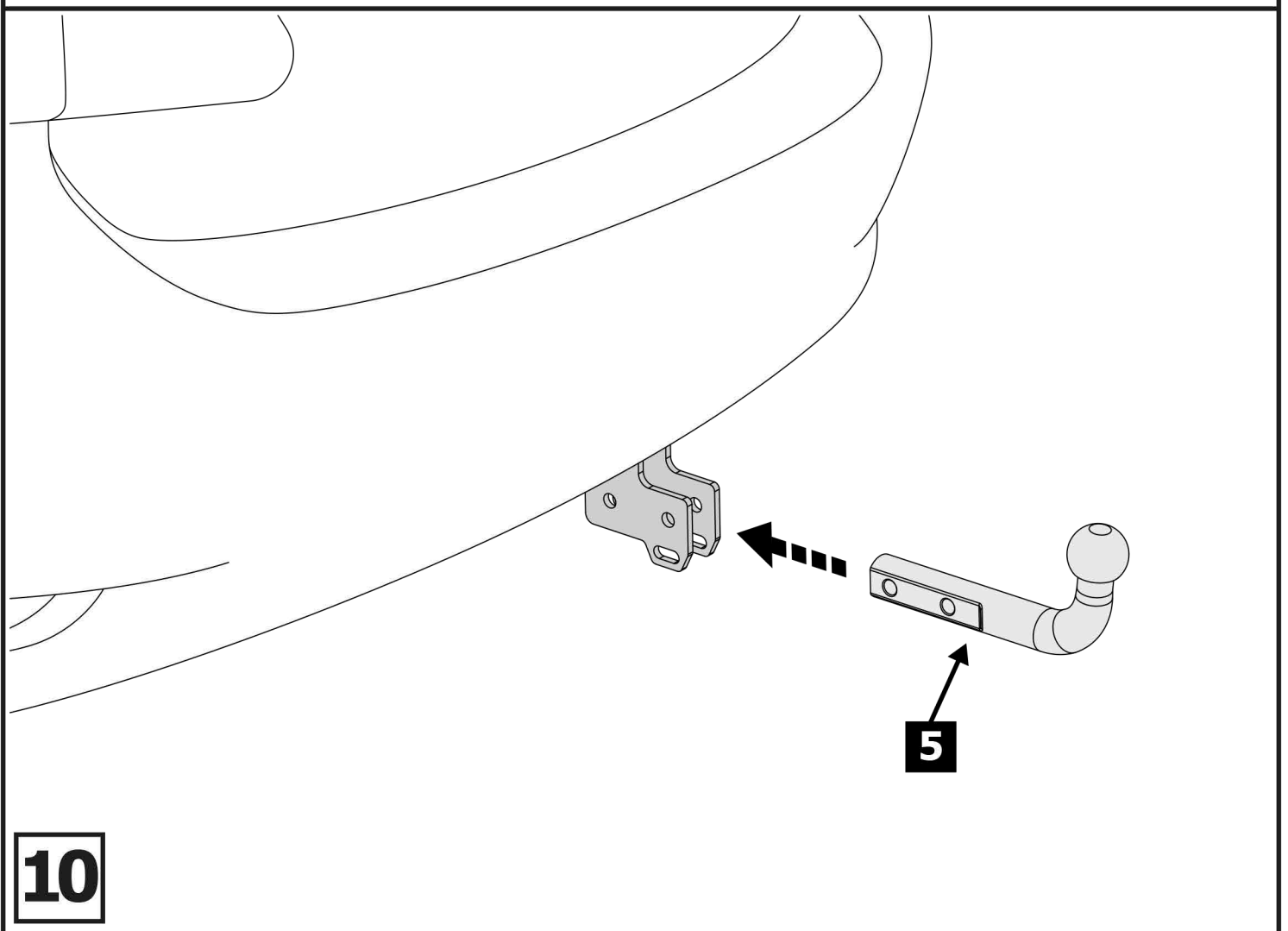
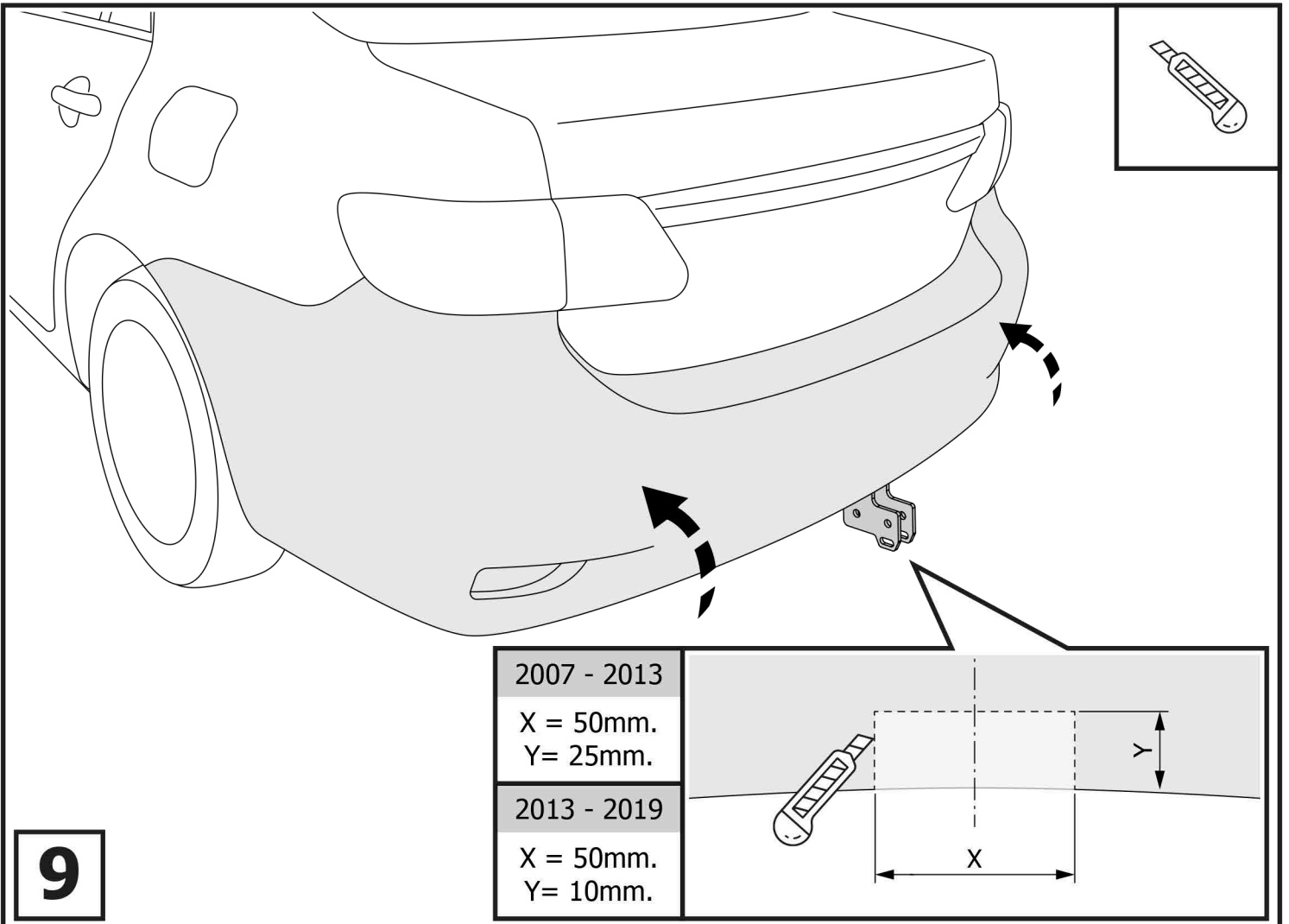

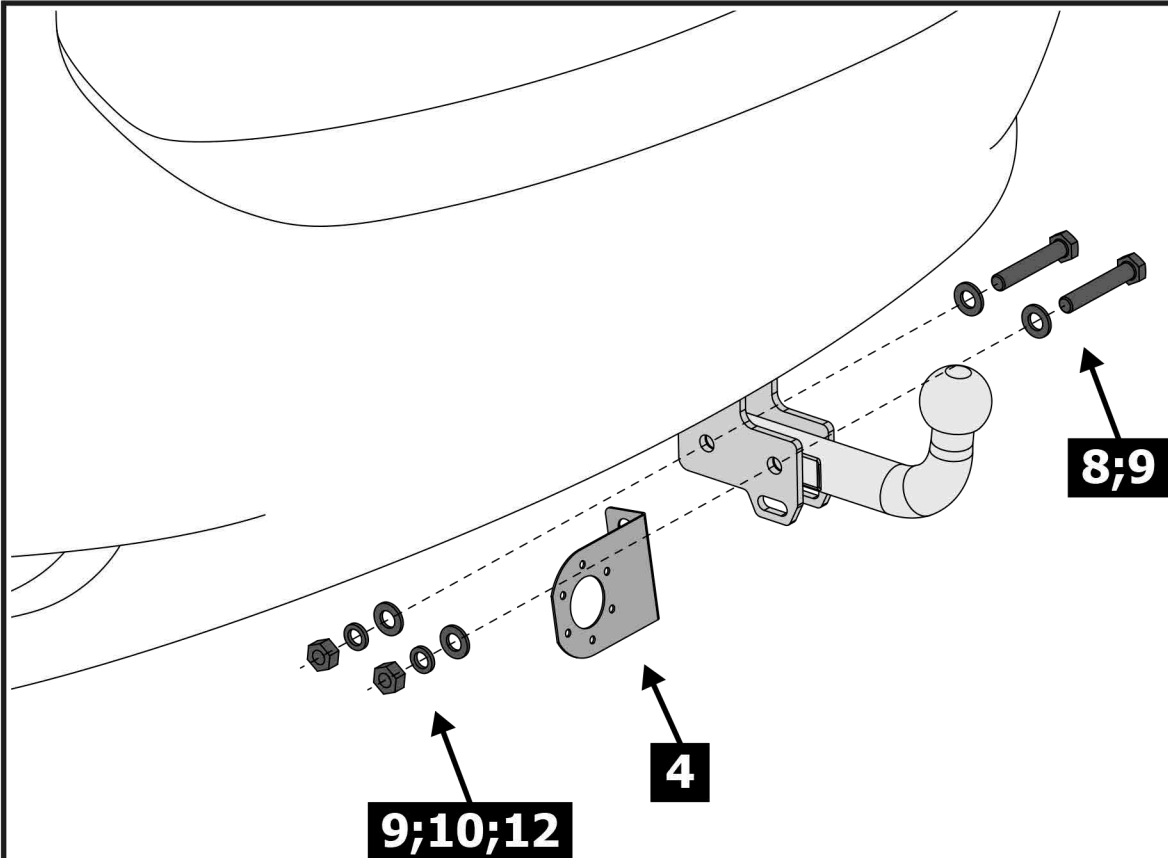
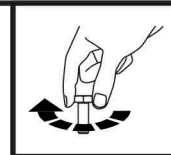

9;10;12

4

8;9

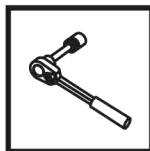

**Затянуть все резьбовые соединения
M12 = 84 Nm**

11